

# SM500i-II

## Surface-Mount Speaker

Preliminary Technical Information for System Engineers



**SOUNDTUBE**  
ENTERTAINMENT



### Preliminary Specifications: SM500i-II

#### Mounting hardware included

System Type	5.25-inch, coaxial, surface-mount, ported (64-watt transformer for 25/70.7/100-volt or transformer bypass)
Impedance (Nominal) <sup>1</sup>	4 ohm
Sensitivity dB @ 2.83V / 1 M	86.0 dB
Sensitivity dB @ 1 W/1 M <sup>2</sup>	83.0 dB
Frequency Response (-3 dB) <sup>3</sup>	86 Hz - 22 kHz
Frequency Response (-10 dB) <sup>3</sup>	60 Hz - 22 kHz
Max. Program Power <sup>4</sup>	150 W
Max. Continuous Power RMS <sup>5</sup>	75 W
Max. SPL dB @ 1 M RMS <sup>6</sup>	102 dB
Coverage Angle (-6 dB @ 2 kHz)	75° horizontal / 90° vertical
Coverage Angle (-6 dB @ 10 kHz)	120° horizontal / 125° vertical
Coverage Angle (Avg. 2 to 10 kHz)	100° horizontal / 100° vertical
Aiming Angle (radial)	360°
Aiming Angle (horizontal)	0 - 90°
Directivity Factor (Q)	4.6 (Averaged 100 Hz - 10 kHz); 9.8 @ 2 kHz
Directivity Index (DI)	5.6 dB (Averaged 100 Hz - 10 kHz); 9.9 dB @ 2 kHz
Tap Selector	Six-position rotary switch with transformer bypass
Low-Frequency Driver	1 x 133 mm (5.25 in) polypropylene cone, butyl rubber surround
High-Frequency Driver	25 mm (1.0 in) convex titanium tweeter with waveguide
Low-Frequency Voice Coil	25 mm (1.0 in)
Crossover Frequency	3 kHz
Network Type: Low-Pass	12 dB per octave, 2nd order
Network Type: High-Pass	12 dB per octave, 2nd order
Enclosure Material	Injection-molded ABS, glass fiber reinforced
Grille	Aluminum with powder-coat finish
Inputs	Four-pin, 5.08 mm Euroblock for individual or daisy chain connection
Colors	Black or white (Custom colors available)
Height	289.56 mm (11.40 in)
Width	212.26 mm (8.36 in)
Depth (Including Bracket)	266.30 mm (10.48 in)
Weight	4.3 kg (9.5 lbs)
Shipping Weight	5.0 kg (11 lbs)
Included Accessories	Safety cable with speaker mounting bolt, Euroblock connector, wall mount bracket and terminal weather boot
Optional Accessories	N/A
Packaging	One per box
Regulatory - UL	1480 (UEAY) planned
Regulatory - CE	Approved
RoHS	Approved

<sup>1</sup> Impedance listed per IEC 60268-5

<sup>2</sup> 1w1m sensitivity determined using nominal impedance

<sup>3</sup> Frequency response measured in half or full space as dictated by speaker mounting configuration

<sup>4</sup> Max program power is 3 dB above max continuous power

<sup>5</sup> Continuous power rating, EIA-426-B test

<sup>6</sup> Max output based on max continuous power

#### Transformer Taps

70.7 V	Output	100 V	Output	25 V	Output
64 W	101.0 dB	64 W	101.0 dB	8 W	92.0 dB
32 W	98.0 dB	32 W	98.0 dB	4 W	89.0 dB
16 W	95.0 dB	16 W	95.0 dB	2 W	86.0 dB
8 W	92.0 dB	8 W	92.0 dB	1 W	83.0 dB
4 W	89.0 dB				

### Key Features

- BroadBeam® waveguide technology delivers a consistent dispersion pattern up to 10 kHz for maximum coverage area per speaker.
- One 5.25 inch (133 mm) polypropylene woofer and one 1.0 inch (25 mm) convex titanium tweeter with FerroFluid™ cooling.
- 86.0 dB average sensitivity offers high output capabilities and reduced amplification costs.
- Includes stainless steel screws and weatherized components for indoor and outdoor applications (SM500i-II-WX available for severe weather installations).
- Easy access, six-position selectable tap switch for 25-, 70.7- and 100-volt applications with transformer bypass position.
- Patented ZeroReflection™ enclosure technology for optimal sound reproduction and cabinet rigidity.
- Aluminum grille with powder-coat finish
- Includes the new SM500i-II Stealth™ bracket mounting system.
- Vertical and horizontal pivoting allow the SM500i-II to be aimed anywhere within the installation space.
- Low profile enclosure design keeps the speaker close to the wall.
- UL 1480 (UEAY) planned.
- High-quality black or white paint finish.
- Included Accessories: Safety cable with speaker mounting bolt, Euroblock connector, wall mount bracket and terminal weather boot.

### Description

The SM500i-II is a 5.25-inch, two-way surface-mount speaker with a midsize enclosure design that delivers effective low-end response (60 Hz) and optimal off-axis performance (2 to 10 kHz). SoundTube's proprietary BroadBeam® waveguide tweeter system delivers consistent high-performance audio across operating bandwidth.

The SM500i-II speaker design incorporates a low-profile grille, six-position tap switch with transformer bypass and mounting hardware, including the Stealth™ bracket mounting system. The



SM500i-II incorporates a security knob to reduce tampering after placement, unlimited directional aiming, and a low profile.

## Applications

Designed for indoor and damp outdoor (SM500i-II-WX available for severe weather installations) background to mid-level SPL surface-mount applications, the SM500i-II includes the new Stealth™ bracket mounting system, allowing for an increased aiming angle. The system includes a detachable mounting plate designed for premounting in either wall or pole applications. The full frequency dispersion pattern and high sensitivity make the SM500i-II surface-mount speaker ideal for music and paging in retail, amusement, restaurant, airports, hotels, schools and casinos. For applications where additional bass is required, SoundTube's RS1001i-II-T and SM1001p subwoofers provide bass down to 41 Hz (-10 dB).

## BroadBeam® Wide Dispersion Technology

SoundTube's proprietary BroadBeam® technology incorporates a high-frequency waveguide mated to a 1-inch convex aluminum tweeter. BroadBeam® waveguide technology delivers a consistent BroadBeam® dispersion pattern across the upper registers of the frequency spectrum. The result is an audio system requiring fewer speakers with higher intelligibility, offering reduced power needs, shorter installation time and cost savings on shipping and labor.

## Patented SoundTube Technologies

SoundTube Entertainment and the MSE Audio Group are constantly developing new technologies that enhance audio product performance. SoundTube Entertainment innovations are protected by multiple U.S. and international patents, which explicitly cover SoundTube dome, enclosure and dispersion technologies. The MSE Audio Group actively defends its patents in order to protect SoundTube resellers and end users.

## Architectural Specifications

The loudspeaker shall consist of a 133 mm (5.25 in) low-frequency transducer and a 25 mm (1.0 in) high-frequency transducer with a frequency-dividing network installed in a vented enclosure. The low-frequency voice coil diameter shall be 25 mm (1.0 in). The high-frequency transducer shall be constructed of titanium with a proprietary BroadBeam® waveguide.

Performance specifications of a typical production unit shall be as follows: Useable frequency response shall extend from 60 Hz – 22 kHz (-10 dB, half space, independently verified). Measured sensitivity (2.83-volt input, 1 meter) shall be at least 86.0 dB. The speaker shall have a nominal impedance of 4 ohms and be available for 25-, 70.7- and 100-volt modes with transformer bypass. The frequency-dividing network shall have a crossover frequency of 3 kHz with slopes of 12 dB per octave (2nd order) for both low- and high-pass filters. Rated power capacity shall be at least 75 watts continuous (RMS) and conform to EIA-426-B testing. Maximum continuous output at 1 meter shall be 102.0 dB.

Installation for the speaker shall be by the new Stealth™ bracket mounting system. A tool-free system with locking mounting plate for either wall or pole mount applications shall be used. For safety redundancy, a secondary cable shall be included and attached to the speaker chassis via an included 1/4-20 UNC bolt. The external wiring input connector shall be a four-pin, 5.08 mm Euroblock for 8 ohm or distributed systems and shall accept from 10 – 22-gauge wire. The system shall be for indoor/outdoor applications and shall have a weather-resistant terminal boot covering all wire connectors.

The enclosure shall be constructed of injection-molded, glass-reinforced ABS. The grille shall be constructed of powder-coated aluminium for lasting performance. Overall cabinet dimensions shall be no more than 289.56 mm (11.40 in) in height by 212.26 mm (8.36 in) in width by 266.30 mm (10.48 in) in depth (including SM bracket). The unit shall include Euroblock connector and weather boot.

The system shall be the SoundTube SM500i-II for both low- and high-impedance applications.

## SoundTube Entertainment

6430 Business Park Loop Road  
Park City, Utah 84098  
Phone 435.647.9555  
Fax 435.647.9666  
Toll Free 800.647.TUBE  
www.soundtube.com

**All SoundTube products come with a 5-year limited warranty.**



### Preliminary Graphs

#### Frequency Response

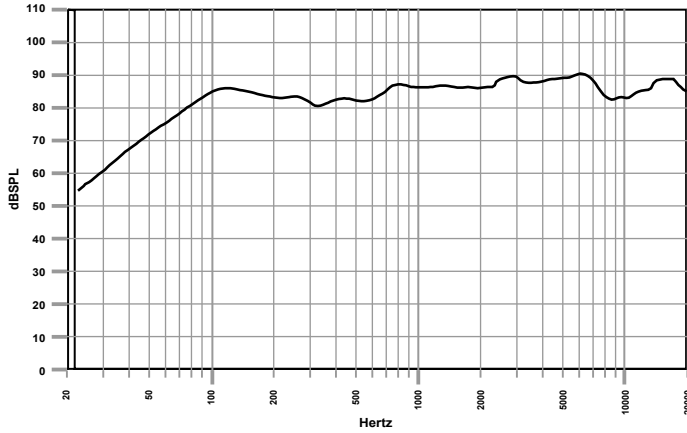

#### Phase/Impedance Response

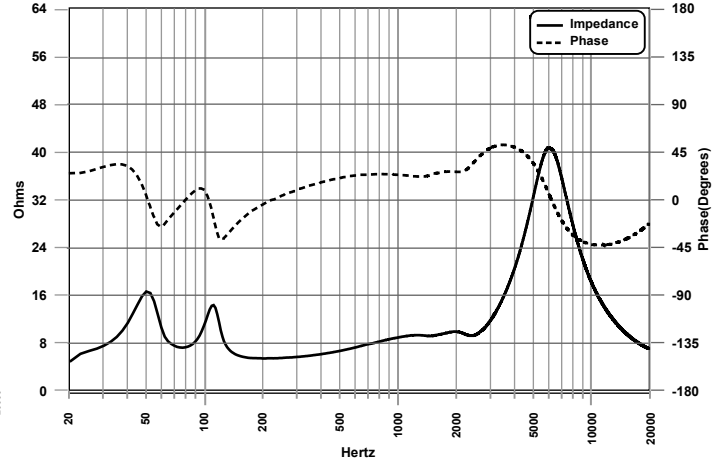

#### Vertical Beamwidth (-6dB)

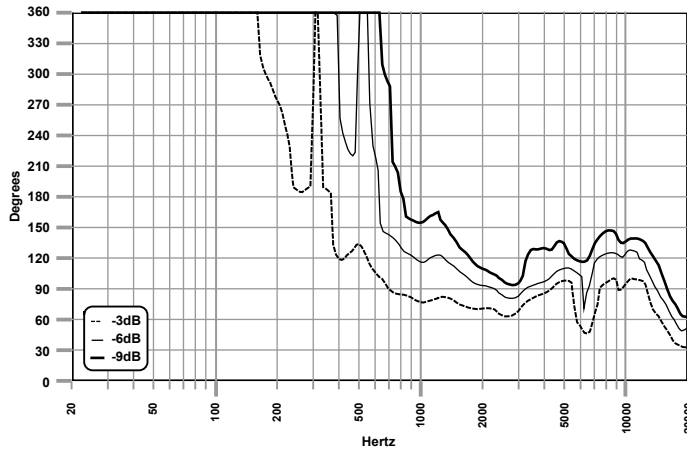

#### Directivity Index (DI)

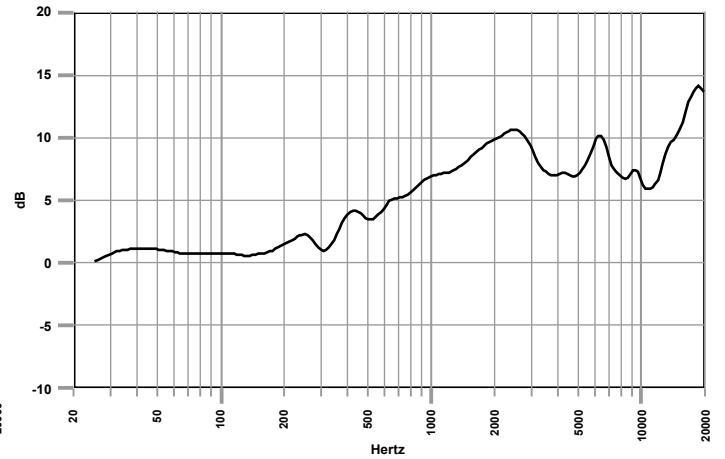



### Preliminary Polar Plots

----- Horizontal  
————— Vertical

125 Hz

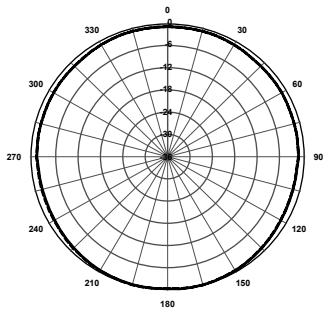

250 Hz

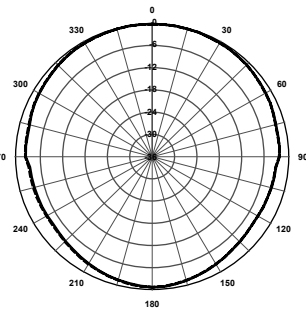

500 Hz

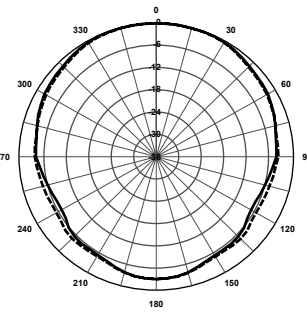

1,000 Hz

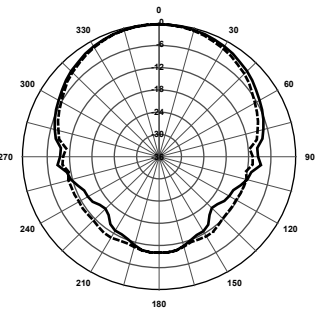

2,000 Hz

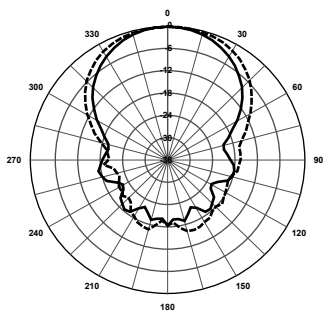

4,000 Hz

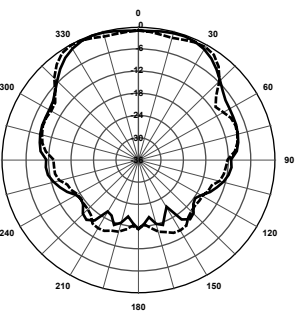

8,000 Hz

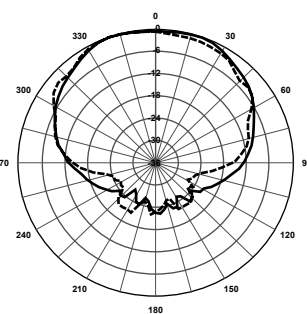

10,000 Hz

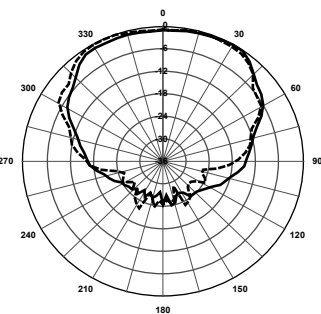

### Mechanical Drawings

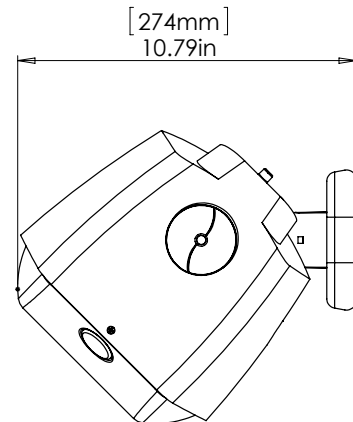
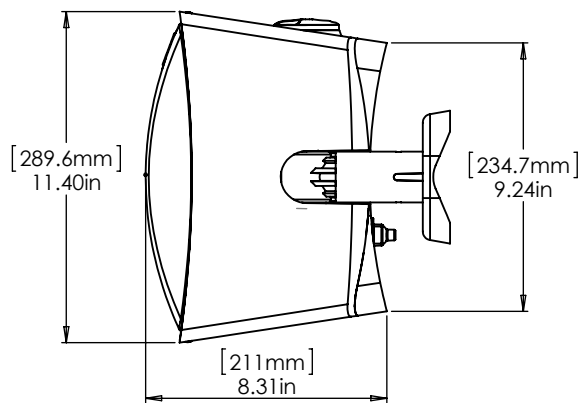
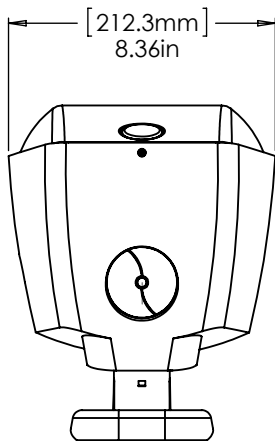

SoundTube Entertainment manufactures a complete line of speakers for:  
**Open-Ceiling • In-Ceiling • Surface-Mount • Outdoor • Sound-Focusing**

All SoundTube products are designed and engineered in the USA.