



Specifications: SM400i

Mounting hardware included

System Type	4-inch, coaxial, surface-mount, ported (20-watt transformer for 25/70.7/100-volt or transformer bypass)
Impedance (Nominal)	4 ohm
Sensitivity dB @ (2.83V / 1 m) ³	85.5 dB
Sensitivity dB @ 1 W/1 m ⁴	82.5 dB
Frequency Response (-3 dB) ¹	97 Hz - 22 kHz
Frequency Response (-10 dB) ¹	76 Hz - 22 kHz
Max. Program Power	35 W
Max. Continuous Power RMS ²	20 W
Max. SPL dB @ 1 m	95.5 dB
Coverage Angle (-6 dB @ 2 kHz)	125° horizontal / 165° vertical
Coverage Angle (-6 dB @ 10 kHz)	75° horizontal / 70° vertical
Coverage Angle (Ave from 2 to 10 kHz)	125° horizontal / 125° vertical
Angle of Pointability	0 to 90° horizontal
Directivity Factor (Q)	3.7 (Averaged 100 Hz - 10 kHz); 3.9 @ 2 kHz
Directivity Index (DI)	4.9 dB (Averaged 100 Hz - 10 kHz); 5.9 dB @ 2 kHz
Tap Selector	Weather-proof, five-position tap switch with transformer bypass position
Low-Frequency Driver	1 x 102mm (4 in) polypropylene cone, butyl rubber surround
High-Frequency Driver	25mm (1 in) convex titanium tweeter with waveguide
Low Frequency Voice Coil	25 mm (1 in)
Crossover Frequency	2.27 kHz
Network Type: Low-Pass	12 dB per octave, 2nd order
Network Type: High-Pass	12 dB per octave, 2nd order
Enclosure Material	Injection-molded ABS, glass fiber reinforced
Grille Material	Powder-coated aluminum
Inputs	Four-pin, 5.08 mm Euroblock for individual or daisy chain connection
Color Options	Black or white (Custom colors available)
Height	246 mm (9.68 in)
Width	177 mm (6.97 in)
Depth (Including Bracket)	190 mm (7.47 in)
Weight	2.4 kg (5.3 lbs)
Shipping Weight	3.3 kg (7.3 lbs)
Included Accessories	Corrosion- and theft-resistant U-bracket mount with safety cable, Euroblock connector, paint mask, terminal weather boot, and port plugs.
Packaging	One per box
Regulatory - UL	1480 (JEAY) approved
Regulatory - CE	Approved
RoHS	Approved

Transformer Taps

	70.7	Output	100 V	Output	25 V	Output
¹ Frequency response is measured in full space.	20 W	95.5 dB	20 W	95.5 dB	3 W	86.5 dB
² Continuous power rating, EIA-426-B test.	10 W	92.5 dB	10 W	92.5 dB	1 W	83.5 dB
³ Average over published frequency response range.	5 W	89.5 dB	5 W	89.5 dB	0.63 W	80.5 dB
⁴ 1 W 1 m sensitivity based on voltage required to yield 1 W based on the minimum system impedance.	3 W	86.5 dB			0.31 W	77.5 dB

Key Features

- BroadBeam[®] waveguide technology delivers a consistent dispersion pattern up to 10 kHz for maximum coverage area per speaker (independently verified).
- One 4 inch (102 mm) polypropylene woofer and one 1 inch (25 mm) convex titanium tweeter with FerroFluid cooling.
- Includes port plugs and weatherized components for indoor and outdoor applications.
- Patented ZeroReflection[™] enclosure technology for optimal sound reproduction and cabinet rigidity.
- Easy access, five-position selectable tap switch for 25-, 70.7- and 100-volt applications with transformer bypass position.
- Iridite-plated aluminum grille with protective powder-coated finish for lasting durability.
- Includes a tool-free Stealth[™] U-bracket mounting system for fast and secure installation.
- Vertical and horizontal mounting offer precision aiming for indoor and outdoor applications.
- UL 1480 (UEAY) and CE approved.
- High quality black or white paint finish. Custom colors available.
- Included accessories: corrosion and theft resistant U-bracket mount with safety cable, Euroblock connector, paint mask, terminal weather boot, and port plugs.
- Optional port plugs are included for added weather resistance.

Description

The SM400i is a 4-inch, coaxial, ported speaker with a low-profile surface-mount enclosure design for indoor/outdoor applications that delivers a consistent dispersion pattern (2 to 10 kHz, independently verified.) Mounting hardware is included and features a corrosion and theft resistant Stealth[™] U-bracket for easy and secure installation. Nearly invisible from sightlines, the Stealth[™] U-bracket includes one way fasteners for tool-free, theft-resistant security. SoundTube's custom-engineered driver and electro-acoustic network deliver high-performance sound in a cost-effective surface-mount speaker design. The SM400i speaker incor-



porates a five-position tap switch with transformer bypass position for simplified ordering and stocking. Included port plugs can be used for added weather resistance.

Applications

Engineered with professional grade components, the SM400i delivers high-quality music and messaging for indoor and outdoor background to mid-level SPL applications. Cost-effective engineering with high-performance sound makes the SM400i speaker ideal for applications including retail, grocery stores, restaurants, hotels, casinos, museums, trade shows and conference rooms. For applications where additional bass is required, SoundTube's RS1001i-II-T and SM1001p subwoofers provide bass down to 41 Hz.

BroadBeam® Wide Dispersion Technology

SoundTube's proprietary BroadBeam® technology incorporates a high-frequency waveguide mated to a 1-inch convex aluminum tweeter. BroadBeam® waveguide technology delivers a consistent BroadBeam® dispersion pattern across the upper registers of the frequency spectrum. The result is an audio system requiring fewer speakers with higher intelligibility, offering reduced power needs, shorter installation time and cost savings on shipping and labor.

Patented SoundTube Technologies

SoundTube Entertainment and the MSE Audio Group constantly develop new technologies that enhance audio product performance. SoundTube Entertainment innovations are protected by multiple U.S. and international patents, which explicitly cover SoundTube dome, enclosure and dispersion technologies. The MSE Audio Group actively defends its patents in order to protect SoundTube resellers and end users.

Technical Data and Specification Tools

Technical Data

SoundTube Entertainment strives to provide complete and effective technical information and data to dealers, engineers and designers. All data are available from SoundTube Entertainment or at www.soundtube.com.

Technical data and downloads include:

EASE™ data – 3-D polar plots.

EASE™ Address – 2-D modeling for distributed systems

Autodesk® Revit® software

Tech Sheets – Technical information and architectural specs for system engineers

SoundTubeSPEC™ – Proprietary speaker placement software

Independent Data Acquisition and Verification

All data for SoundTube speakers are independently collected and verified by NWA Labs (www.nwaalabs.com) using their proprietary MACH testing system. All data are collected and analyzed according to ASTM, ISO and AES standards using EASERA, TEF and MLSSA. Full balloon data including both phase and magnitude are compiled into a variety of formats including EASE 4.x, GLL and CLF.

Architectural Specifications

The loudspeaker shall consist of a 102 mm (4 in) polypropylene woofer and one 25 mm (1 in) convex titanium tweeter with FerroFluid cooling.

Performance specifications of a typical production unit shall be as follows: Useable frequency response shall extend to 76 Hz (-10 dB, full space, independently verified). Measured sensitivity (2.83-volt input, 1 meter) shall be at least 85.5 dB. The speaker shall have a nominal impedance of 4 ohms and be available for 25-, 70.7- and 100-volt modes and transformer bypass. The frequency dividing network shall have a crossover frequency of 2.27 kHz with slopes of 12 dB per octave (2nd order) for both low- and high-pass filters. Rated power capacity shall be at least 20 watts continuous (RMS) and conform to EIA-426-B testing. Maximum continuous output at 1 meter shall be 95.5 dB.

The low-frequency transducer shall have a polypropylene cone with butyl rubber

surround. The high-frequency transducer shall be constructed of titanium with a proprietary BroadBeam® waveguide.

Installation and safety attachment for the speaker shall be by Stealth U-bracket affixed to the speaker chassis via ABS handle with steel insert and shall include a safety cable for safety redundancy. The external wiring input connector shall be a four-pin, 5.08 mm Euroblock for 4 ohm or distributed systems and shall accept from 10 – 22-gauge wire. The system shall be for indoor and outdoor applications and shall have a weather-resistant terminal boot covering all wire connectors.

The enclosure shall be constructed of injection-molded ABS with optional port plug for added weather resistance. The plugs shall be constructed of closed-cell foam. The grille shall be constructed of powder-coated aluminum for lasting performance in the elements. The unit shall include mounting hardware, Euroblock connector and weather-resistant terminal boot. The maximum overall cabinet dimensions shall be 245.9 mm (9.68 in.) in height by 177.0 mm (6.97 in.) in width by 189.7 mm (7.47 in.) in depth (including Stealth™ bracket)

The system shall be the SoundTube SM400i with mounting hardware for both low- and high-impedance applications.

SoundTube Entertainment

6430 Business Park Loop Road
Park City, Utah 84098
Phone 435.647.9555
Fax 435.647.9666
Toll Free 800.647.TUBE
www.soundtube.com

All SoundTube products come with a 5-year limited warranty.

Frequency Response

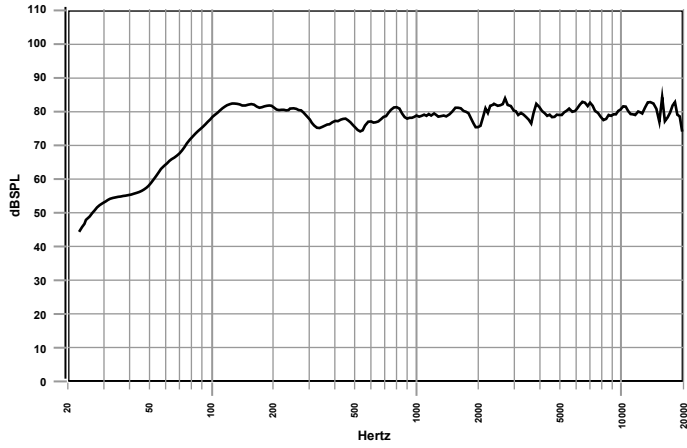

Phase/Impedance Response

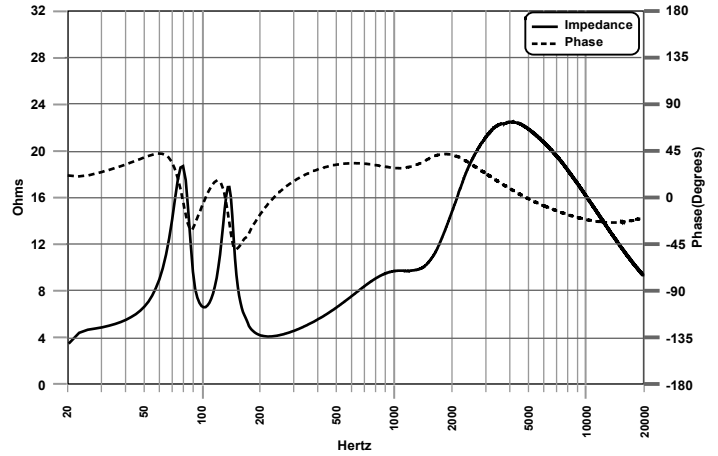

Vertical Beamwidth (-6dB)

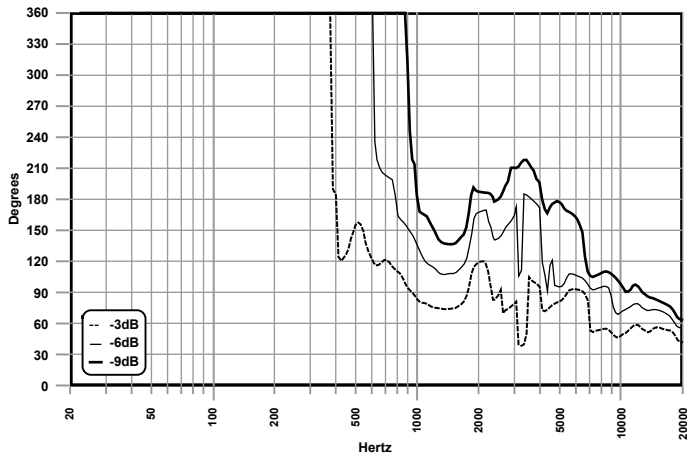

Directivity Index (DI)

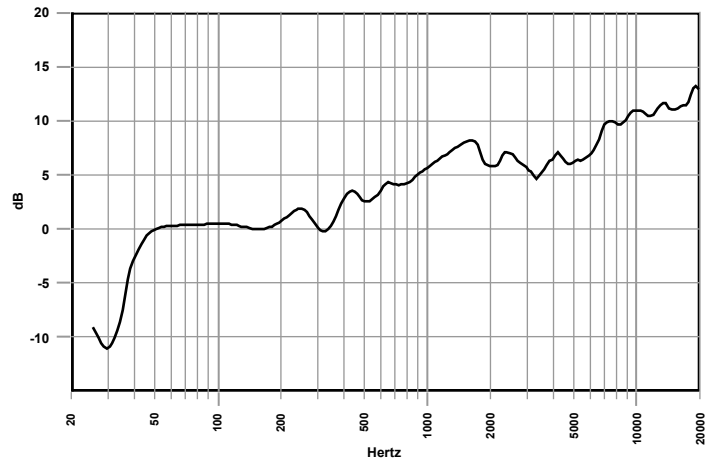



Polar Plots

----- Horizontal
 ————— Vertical

125 Hz

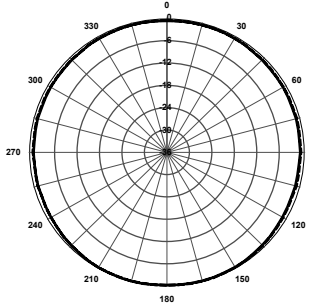

250 Hz

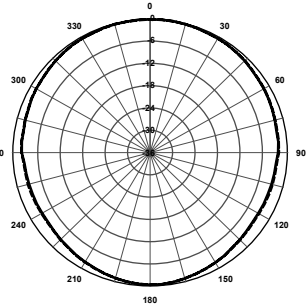

500 Hz

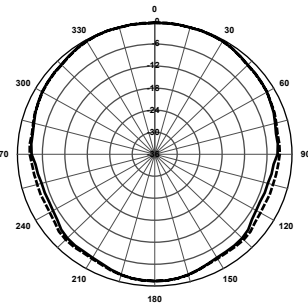

1,000 Hz

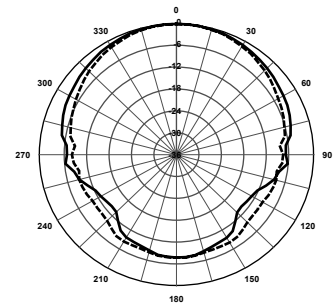

2,000 Hz

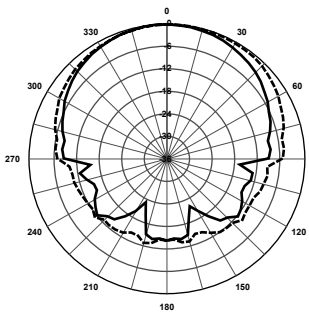

4,000 Hz

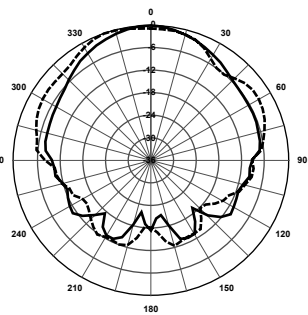

8,000 Hz

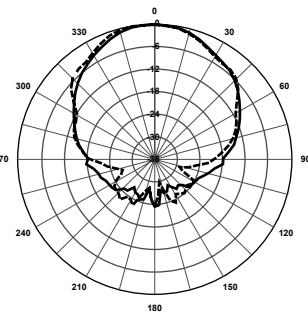

10,000 Hz

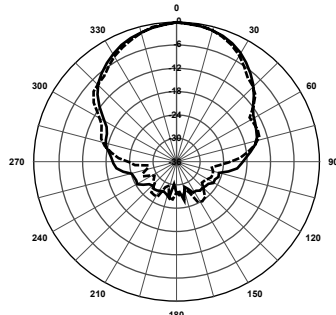

Mechanical Drawings

