



Preliminary Specifications: IPD4-CM52-BGM

Tile bridge included

System Type	5.25 inch coaxial, in-ceiling, ported, Dante™-enabled, network
Frequency Response (-3 dB) ¹	67 Hz - 20 kHz
Frequency Response (-10 dB) ¹	56 Hz - 22 kHz
Max. Power SPL @ 1 m ²	93.0 dB
Coverage Angle (-6 dB @ 2 kHz)	180°
Coverage Angle (-6 dB @ 10 kHz)	112°
Coverage Angle (averaged 2-10 kHz)	141°
Directivity Factor (Q)	3.8 (averaged 100 Hz - 10 kHz) ; 2.1 (2 kHz)
Directivity Index (DI)	5.1 dB (averaged 100 Hz - 10 kHz) ; 3.3 dB (2 kHz)
Transducer - Low-Frequency Driver	134 mm (5.25 in.) Polypropylene cone, rubber surround
Transducer - High-Frequency Driver	19 mm (0.75 in.) Silk dome tweeter
Low-Frequency Voice Coil	25.4 mm (1.0 in.)
Crossover Frequency	5.0 kHz
Network Type: Low Pass	12 dB per octave, 2nd order
Network Type: High Pass	12 dB per octave, 2nd order
Enclosure Material	Drawn steel backcan with ABS baffle
Grille	Painted steel
Inputs	RJ45 ethernet port
Colors	White
Backcan Diameter	245.6 mm (9.67 in.)
Backcan Height	146.1 mm (5.75 in.)
Visible Diameter	298.5 mm (11.75 in.)
Visible Height	8.6 mm (0.34 in.)
Mounting Hole Diameter	266.7 mm (10.5 in.)
Min - Max Ceiling Thickness	0.9 mm (0.035 in.) - 63.5 mm (2.5 in.)
Weight	3.6 kg (8.0 lbs.)
Shipping Weight	4.1 kg (9.0 lbs.)
Packaging	One per box
Included accessories	Tile bridge, UL-listed flex conduit clamp, paint shield, hole template, wire nuts
Optional accessories	Pre-construction bracket (AC-CM6/8-PCB)
Regulatory - UL	UL 60065 & UL 2043 listed
Regulatory - CE	Approved
RoHS	Approved

1. Frequency response measured in half or full space as dictated by speaker mounting configuration

2. Max output based on max continuous power

Preliminary Technical Information

- IP-addressable, self powered (PoE) speaker with audio and power outputs for three standard CM52-BGM speakers.
- Dante™ I/O for interconnectivity with Dante-enabled audio systems.
- One 5.25 inch (134 mm) polypropylene woofer with rubber surround and one 0.75 inch (19 mm) silk dome tweeter.
- BroadBeam Ring™ technology for mid-range clarity and ultra wide off axis performance.
- Fast connection of power, audio and control functions via one CAT5 or CAT6 cable.
- 40 watts PoE provided by SoundTube STNet-Switch; also works with Standard PoE plus and PoE switches.
- Input power is shared among speakers connected to IPD4 unit.
- Two output channels available to additional speakers.
- Provides report-back on any problems via SoundTube software.
- Tuned port on baffle for added musicality and bass response down to 56 Hz (-10 dB).
- Incorporates a painted steel grille for lasting durability.
- SpeedWing™ clamping system is adaptable to material thicknesses ranging from 0.035 in. (0.9 mm) to 2.5 in. (63.5 mm).
- UL 60065 and 2043 listed.
- High-quality white painted finish. Custom colors available
- Included accessories: Color-coded (green) tile bridge, UL listed conduit clamp, paint shield.
- Optional accessories: Color-coded (green) pre-construction bracket (AC-CMEZ6/8-PCB).

Description

The IPD4-CM52-BGM is a 5.25-inch coaxial in-ceiling speaker for IP-addressable audio networks on the Dante platform which can provide economical system expansion through connection of up to three non-IP SoundTube CM52-BGM speakers directly to the IPD4 unit. It incorporates a 5.25-inch polypropylene driver with butyl rubber surround and a 1-inch silk dome tweeter in a sealed drawn steel backcan with a tuned port. The speaker delivers frequency response of 65 Hz – 22 kHz (-10 dB) with consistent, broad high frequency dispersion supplied through SoundTube's proprietary BroadBeam Ring™ technology.

Power, audio and control are delivered to the speaker via a CAT5 or CAT6 cable; connection on the other end is made to the STNet-Switch, which provides 40 watts PoE (Power over Ethernet) to each speaker. The speaker may also be connected to standard PoE or PoE Plus switches, which will provide lower input power to the speaker cluster; input power to the IPD4-CM52-BGM is shared among all speakers in the master-slave cluster. Audio connection to non-IP speakers in the cluster is made via a terminal strip on the IPD4 speaker; two channels of audio are available at each IPD4-CM52-BGM master unit and may be directed to the other speakers as needed.

Configuration and zoning of the IPD4 master speaker is done via software. Should any problem occur with the speaker during operation, it will be reported immediately via SoundTube monitoring software.

Mounting hardware for the IPD4-CM52-BGM is included and features SoundTube's SpeedWing™ constant-tension fixed-wing mounting system, along with a 21-gauge steel tile bridge which ensures rapid and secure installation in any drywall or drop-tile application. The tile bridge is color-coded to match the speaker. An optional pre-construction bracket is also available.

Applications

Developed for economical audio coverage expansion in Dante audio platforms, the IPD4-CM52-BGM is ideal for hotels, museums, houses of worship, education, retail stores, restaurants, airports or corporate installations. This speaker is based on SoundTube's CM-BGM series, which was engineered for high efficiency, good musicality and added bass response, so it is suitable for both background music and paging.

Patented SoundTube Technologies

SoundTube Entertainment and the MSE Audio Group constantly develop new technologies which enhance audio product performance. SoundTube Entertainment innovations are protected by multiple U.S. and international patents, which explicitly cover SoundTube dome, enclosure and dispersion technologies. The MSE Audio Group actively defends its patents in order

to protect SoundTube resellers and end-users.

Technical Data and Specification Tools

Technical Data

SoundTube Entertainment strives to provide complete and effective technical information and data to dealers, engineers and designers. All data are available from SoundTube Entertainment or at www.soundtube.com.

Technical data and downloads include:

EASE™ data – 3-D polar plots.

EASE™ Address – 2-D modeling for distributed systems

Autodesk® Revit® software

Tech Sheets – Technical information and architectural specs for system engineers

SoundTubeSPEC™ – Proprietary speaker placement software

Independent Data

Acquisition and Verification

All data for SoundTube speakers is independently collected and verified by a third party. All data is collected and analysed according to ASTM, ISO and AES standards using EASERA, TEF and MLSSA. Full balloon data including both phase and magnitude is compiled into a variety of formats including EASE 4.x, GLL and CLF.

Architectural Specifications

The loudspeaker shall operate on the Dante™ IP platform and shall accept audio signals directly from Dante-enabled devices through a PoE switch. In addition to its direct connection to the Dante network, the speaker shall provide audio and power outputs for three non-IP speakers of the same sonic performance and construction. Connection to the Dante network shall be made via category cable with Ethernet connector.

Connections to three auxiliary speakers shall be made via terminal strip on the backcan of the speaker. Two audio channels shall be available to auxiliary speakers. Input power to the speaker shall be shared among all speakers connected at the terminal strip.

Performance specifications of a typi-

cal production unit shall be as follows: Usable frequency range shall extend from 56 Hz – 22 kHz (-10 dB). The frequency dividing network shall have a crossover frequency of 5 kHz. The unit shall accept 40 watts PoE in addition to PoE plus and standard PoE, as well as the audio signal from a provided network switch, and shall be configurable via software. Maximum continuous output at 1 meter with a 40 watt input shall be 93 dB. When auxiliary speakers are connected, maximum continuous output shall be 93 dB for each speaker in the cluster.

The backcan shall be constructed of galvanized steel with an ABS plastic baffle. The grille shall be constructed of painted steel. Shipped complete with UL-listed flex conduit connector, color coded tile bridge (to match color-coded backcan), grille, and paint shield, the integrated in-ceiling speaker is engineered for high performance and rapid installation in plenum spaces. The unit incorporates three additional attachment points for added security, or where required by code.

Installation for the speaker shall be by two-screw blind-mount constant-tension fixed-wing assembly and shall attach to ceiling thicknesses ranging from 0.035 in. (0.9 mm) to 2.5 in. (63.5 mm). The external wiring shall be via RJ45 ethernet port, accepting standard CAT 5 or CAT6 ethernet cable.

The maximum backcan dimension shall be no more than 146.1 mm (5.75 in.) in height by 245.6 mm (9.67 in.) in diameter. The maximum visible dimensions shall be no more than 8.4 mm (0.33 in.) in height by 298.5 mm (11.75 in.) in diameter.

The system shall be the SoundTube IPD4-CM52-BGM for Dante™ operation.

SoundTube Entertainment

6430 North Business Park Loop
Park City, Utah 84098
Phone 435.647.9555
Fax 435.647.9666
Toll Free 800.647.TUBE
www.soundtube.com

All SoundTube products come with a 5-year limited warranty.

Graphs

Frequency Response

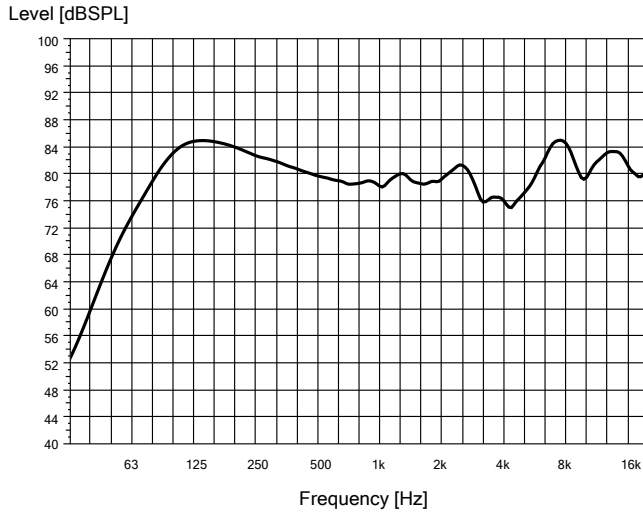

Phase/Impedance Response

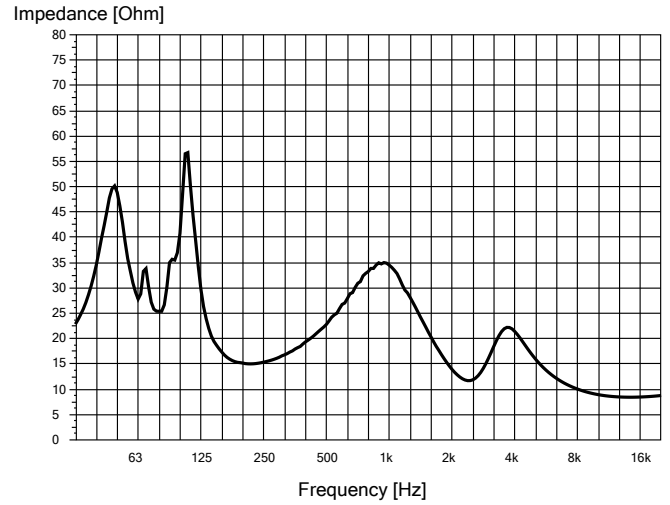

Vertical Beamwidth

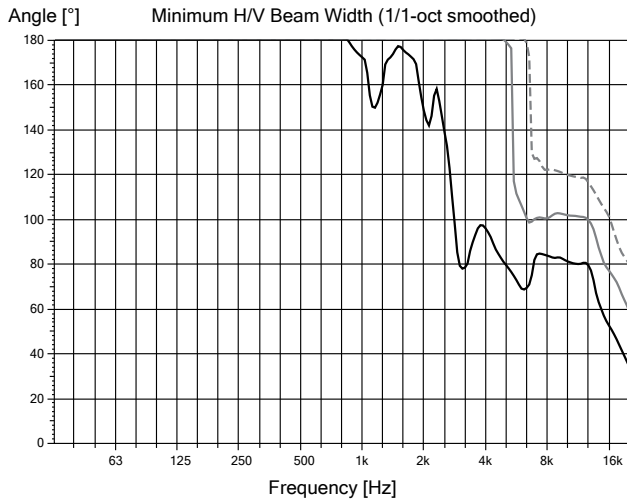

Directivity Index (DI)

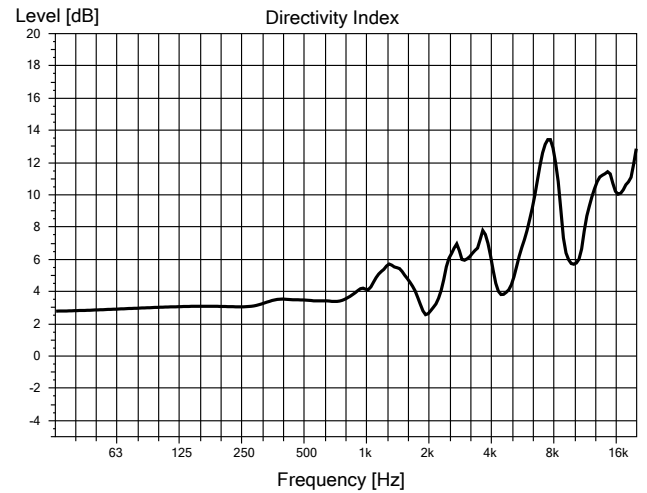



Polar Plots

— Horizontal
- - - Vertical

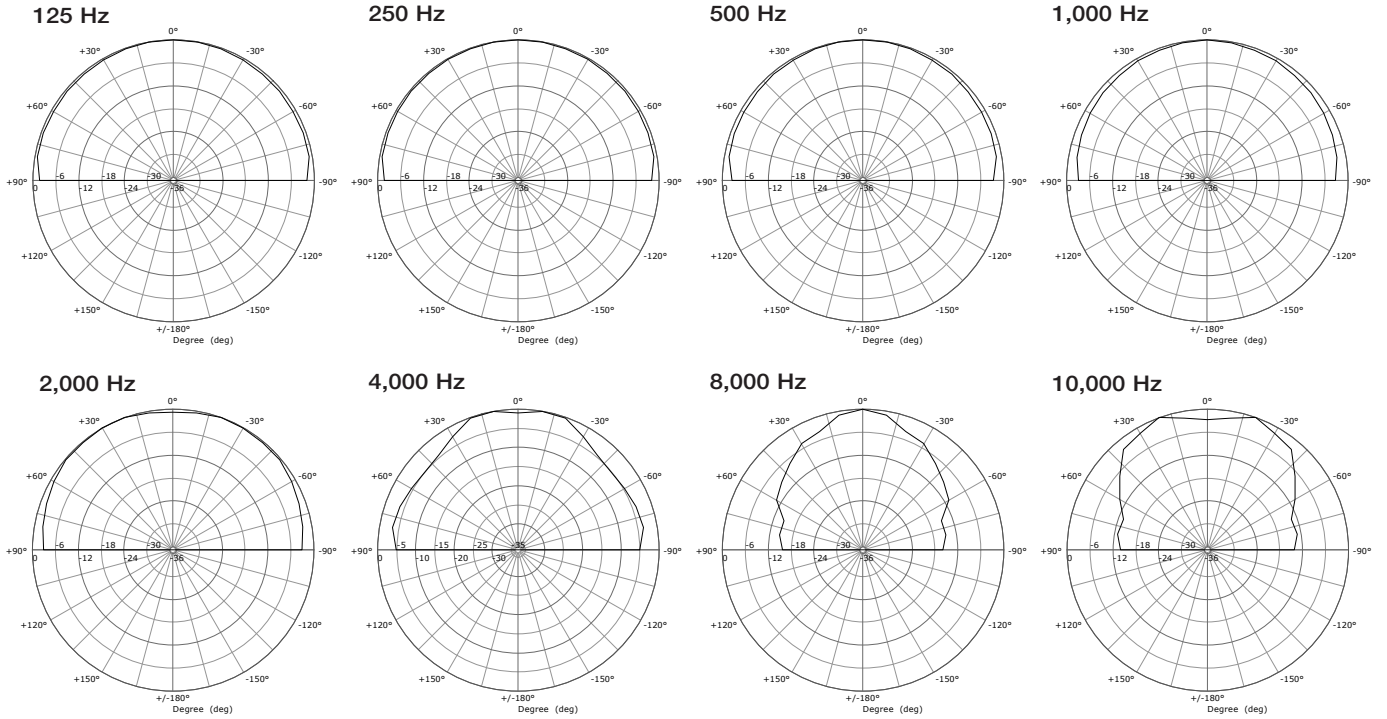

Mechanical Drawings

Side

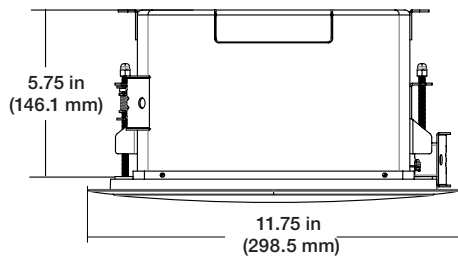

Top

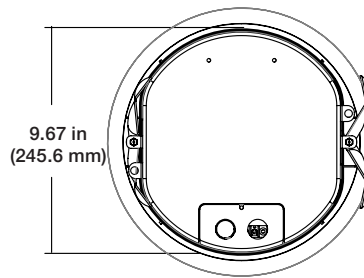

Optional Accessories

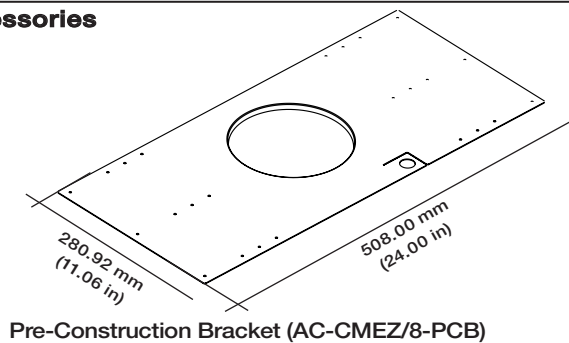

Included Accessories

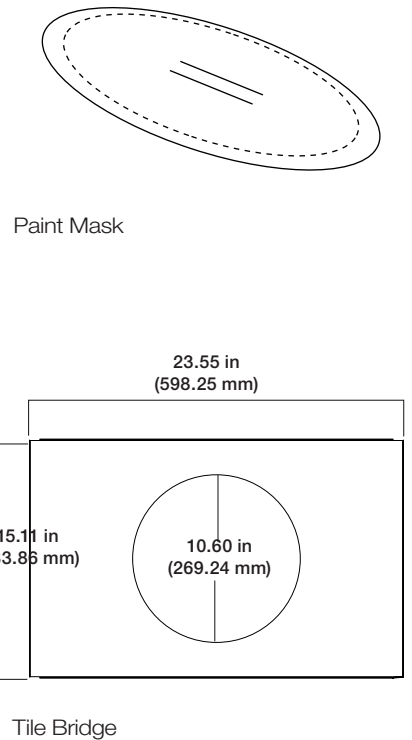

SoundTube Entertainment manufactures a complete line of speakers for:
Open-Ceiling • In-Ceiling • Surface-Mount • Outdoor • Sound-Focusing

All SoundTube products are designed and engineered in the USA.